PF0030 Series

MOS FET Power Amplifier

HITACHI

ADE-208-460 (Z)

1st. Edition

July 1996

Features

- High stability: Load VSWR = 20 : 1
- Low power control current: 400 μ A
- Thin package: 5 mm

Ordering Information

Type No	Operating Frequency	Application
PF0030	824 to 849 MHz	AMPS
PF0032	872 to 905 MHz	E-TACS

Pin Arrangement

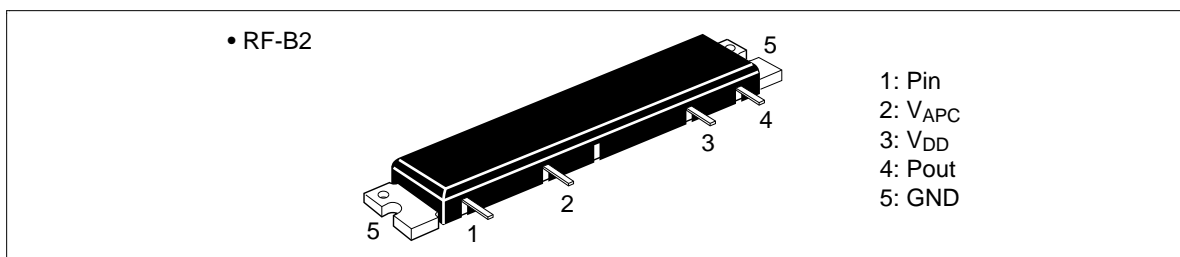

PF0030 Series

Internal Diagram and External Circuit

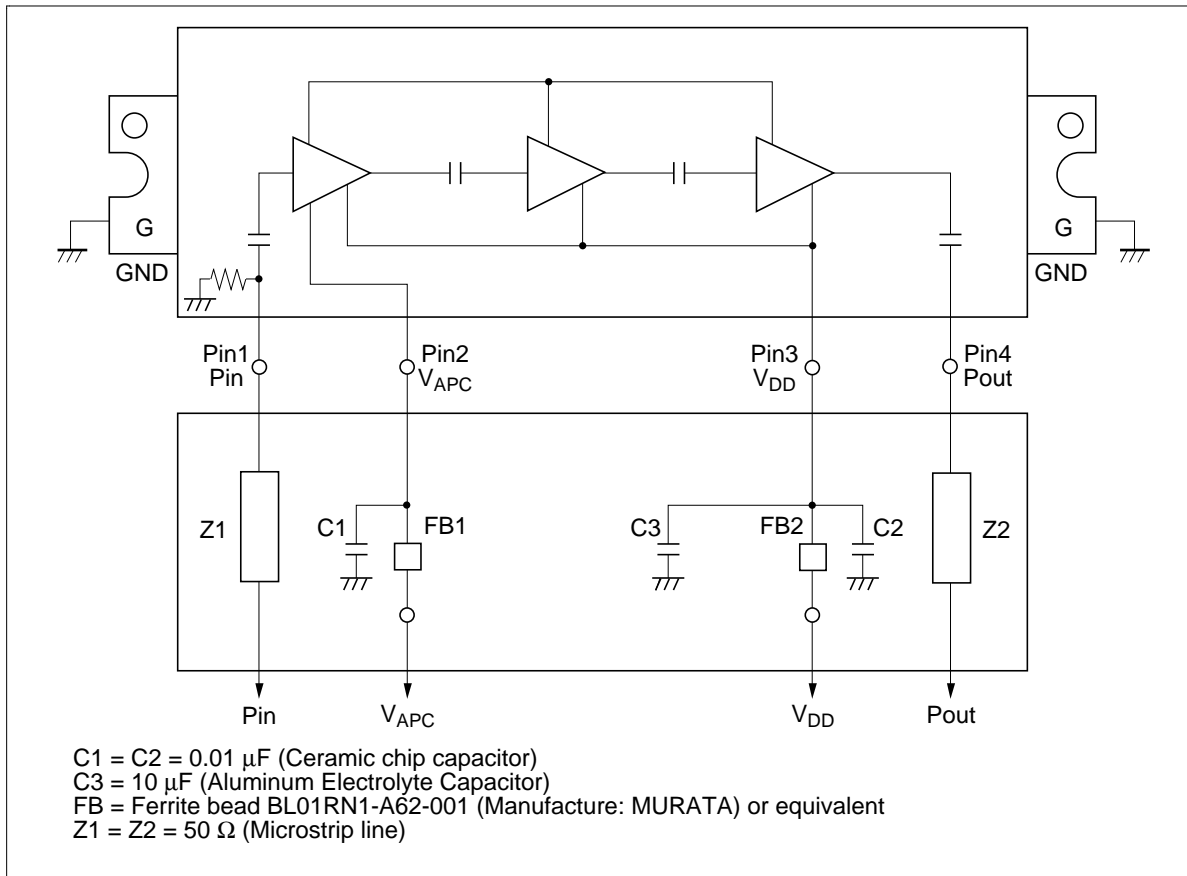

Absolute Maximum Ratings ($T_a = 25^\circ\text{C}$)

Item	Symbol	Rating	Unit
Supply voltage	V_{DD}	17	V
Supply current	I_{DD}	3	A
APC voltage	V_{APC}	± 8	V
Input power	Pin	20	mW
Operating case temperature	T_c (op)	-30 to +110	$^\circ\text{C}$
Storage temperature	T_{stg}	-40 to +110	$^\circ\text{C}$

Electrical Characteristics (Ta = 25°C)

Item	Symbol	Min	Typ	Max	Unit	Test Condition
Drain cutoff current	I_{DS}	—	—	500	μA	$V_{DD} = 17 V, V_{APC} = 0 V$
Total efficiency	η_T	35	40	—	%	$P_{in} = 2 mW,$
2nd harmonic distortion	2nd H.D.	—	-50	-30	dB	$V_{DD} = 12.5 V,$
3rd harmonic distortion	3rd H.D.	—	-50	-30	dB	$P_{out} = 6 W$ (at APC controlled)
Input VSWR	VSWR (in)	—	1.5	3	—	$Z_{in} = Z_{out} = 50 \Omega$
Output VSWR	VSWR (out)	—	1.5	—	—	
Stability	—	No parasitic oscillation			—	$P_{in} = 2 mW, V_{DD} = 12.5 V,$ $P_{out} = 6 W$ (at APC controlled), $Z_{in} = 50 \Omega,$ Output VSWR = 20:1 All phases, $t = 20 sec$

Test System Diagram

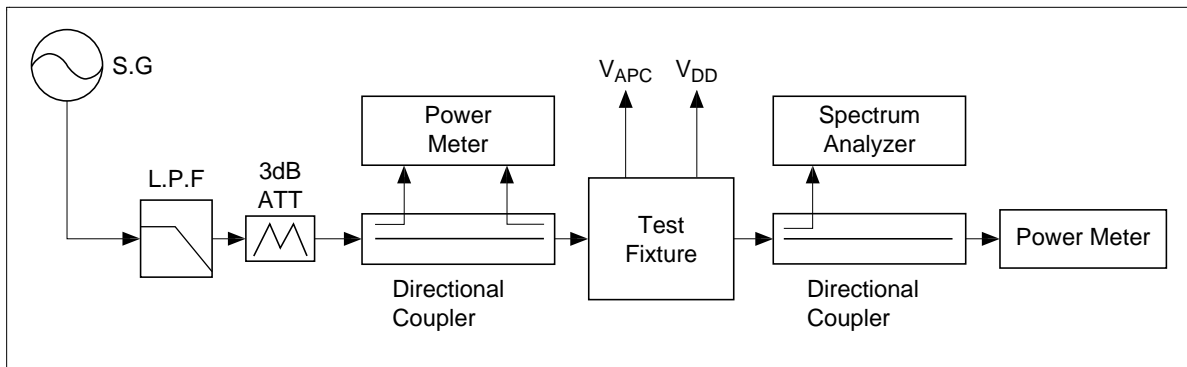

PF0030 Series

Test Fixture Pattern/ Unit: mm

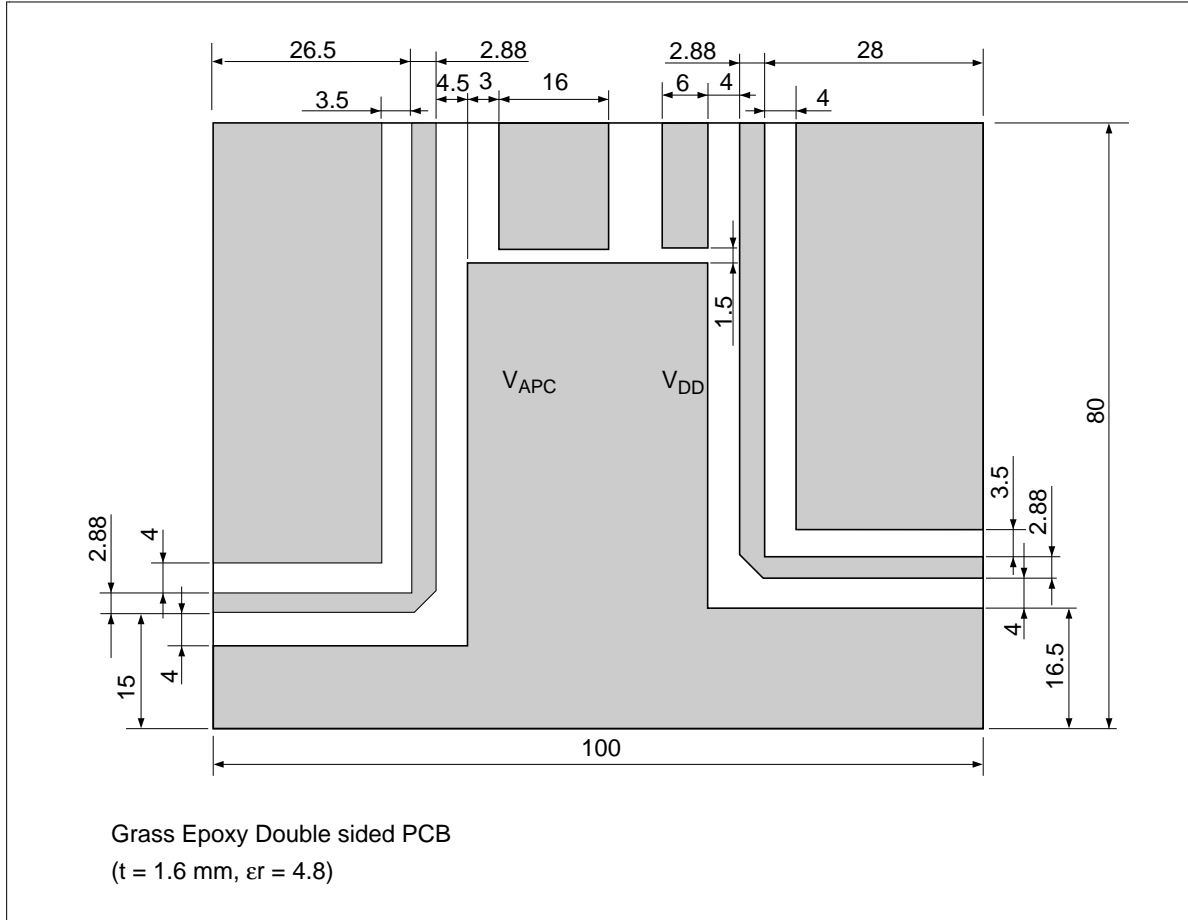

Mechanical Characteristics

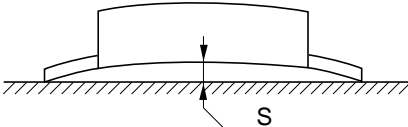
Item	Conditions	Spec
Torque for screw up the heatsink flange	M3 Screw Bolts	4 to 6 kg•cm
Warp size of the heatsink flange: S		S = 0 +0.3/-0 mm

Note for Use

- Unevenness and distortion at the surface of the heatsink attached module should be less than 0.05 mm.
- It should not be existed any dust between module and heatsink.
- MODULE should be separated from PCB less than 1.5 mm.
- Soldering temperature and soldering time should be less than 230°C, 10 sec.
(Soldering position spaced from the root point of the lead frame: 2 mm)
- Recommendation of thermal joint compounds is TYPE G746.
(Manufacturer: Shin-Etsu Chemical, Co., Ltd.)
- To protect devices from electro-static damage, soldering iron, measuring-equipment and human body etc. should be grounded.
- Torque for screw up the heatsink flange should be 4 to 6 kg · cm with M3 screw bolts.
- Don't solder the flange directly.
- It should make the lead frame as straight as possible.
- The module should be screwed up before lead soldering.
- It should not be given mechanical and thermal stress to lead and flange of the module.
- When the external parts (Isolator, Duplexer, etc.) of the module are changed, the electrical characteristics should be evaluated enough.
- Don't washing the module except lead pins.
- To get good stability, ground impedance between the module GND flange and PCB GND pattern should be designed as low as possible.

PF0030 Series

Characteristics Curve

PF0030

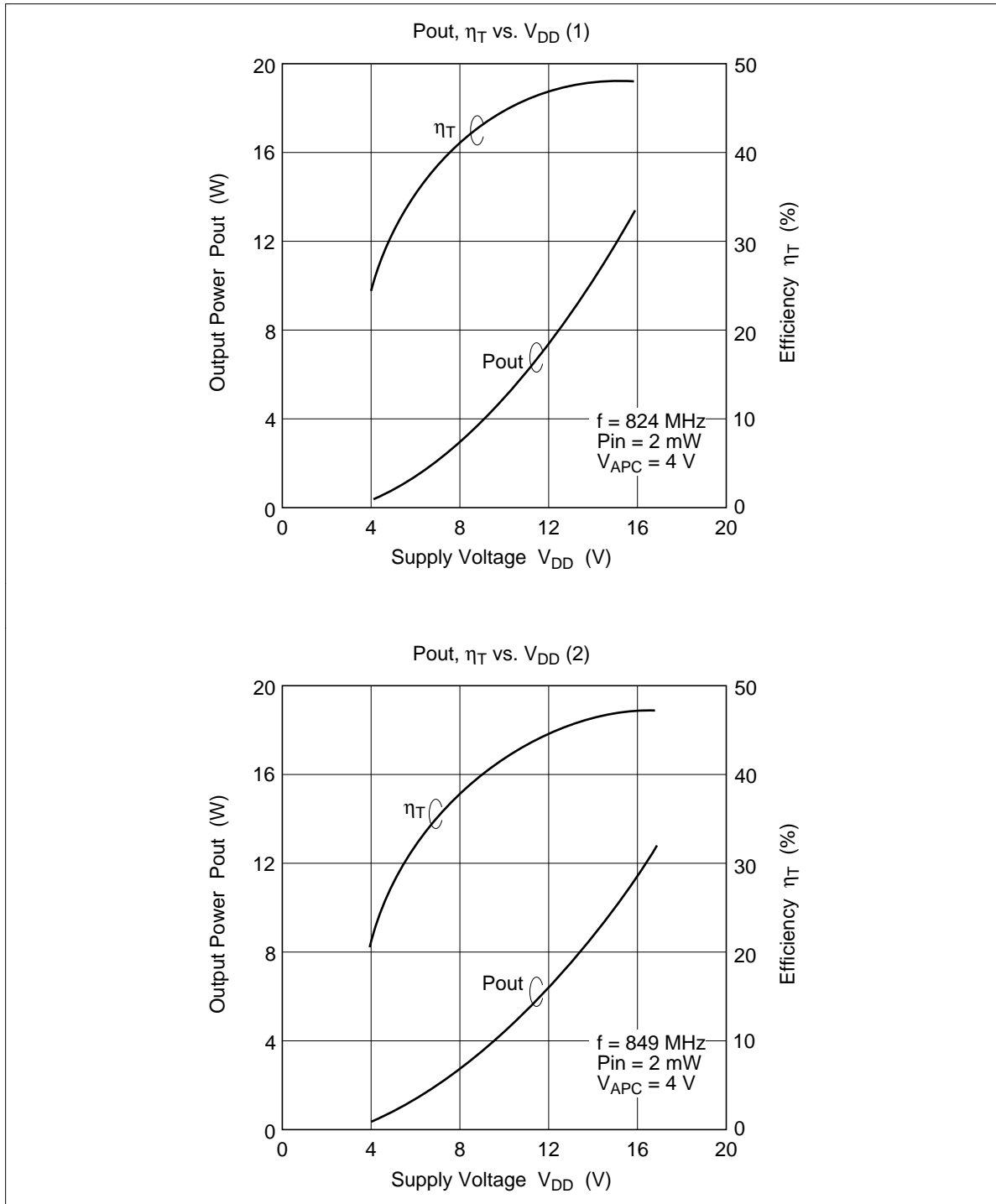

PF0030 (cont)

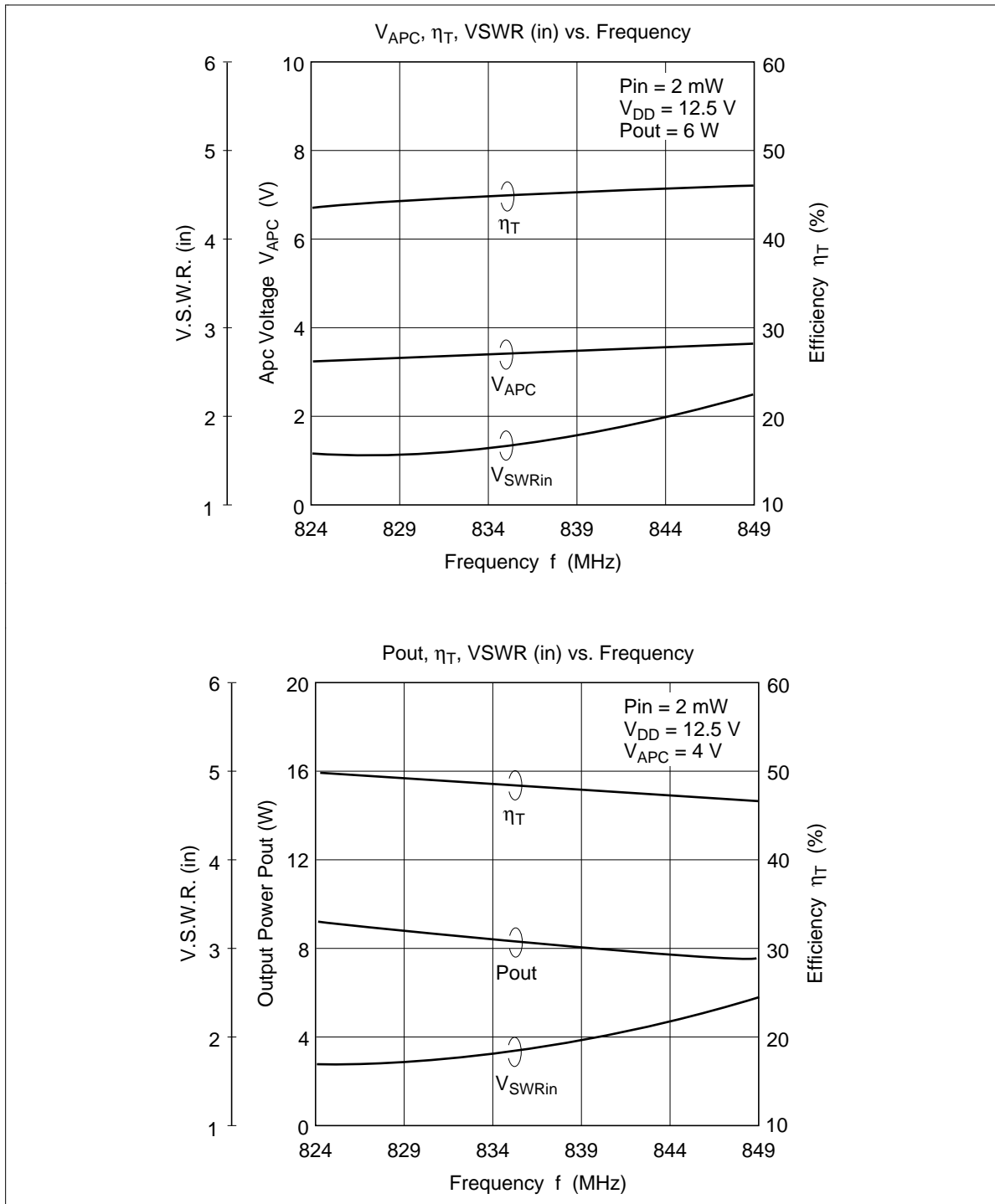

PF0030 Series

PF0030 (cont)

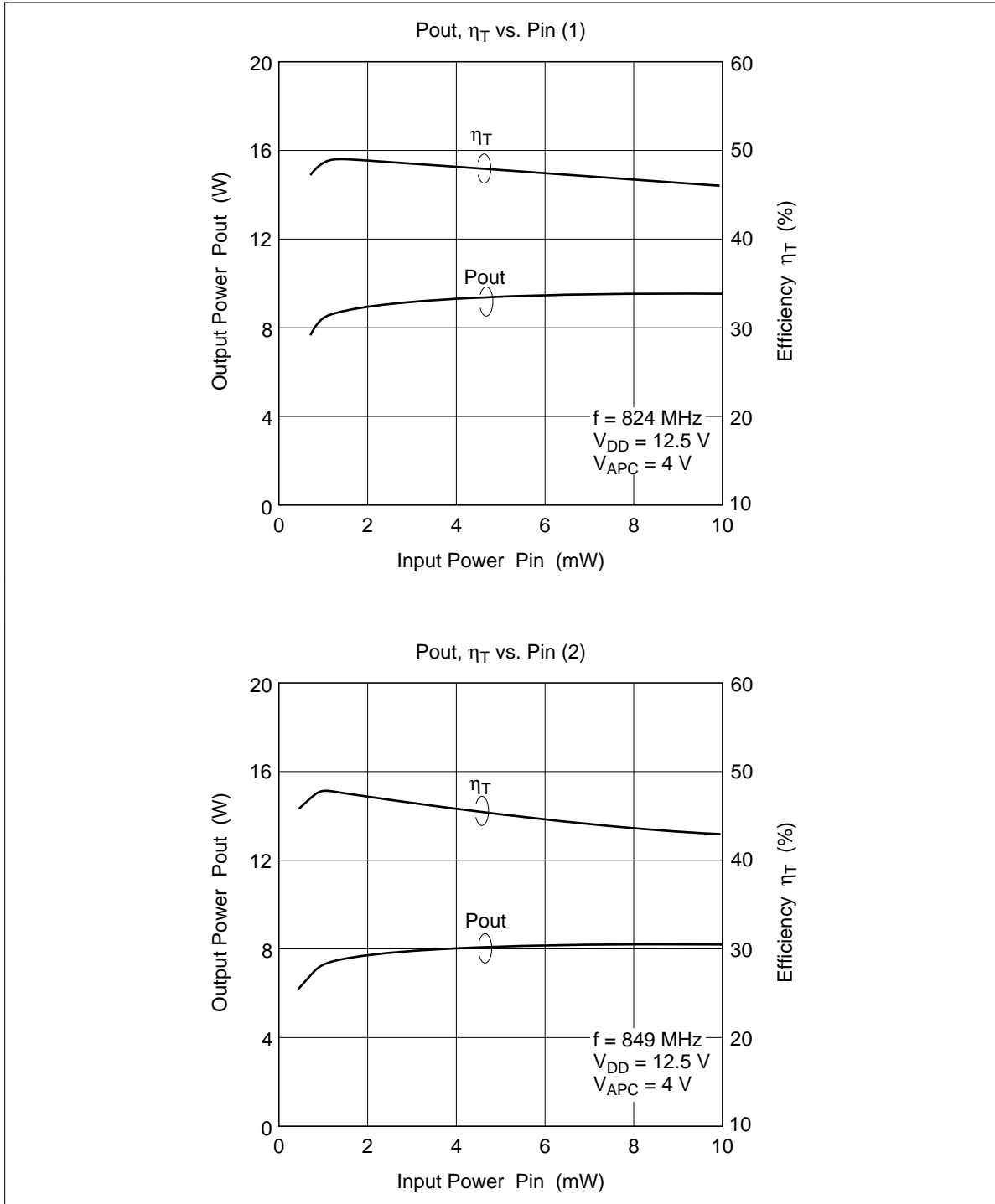

PF0030 (cont)

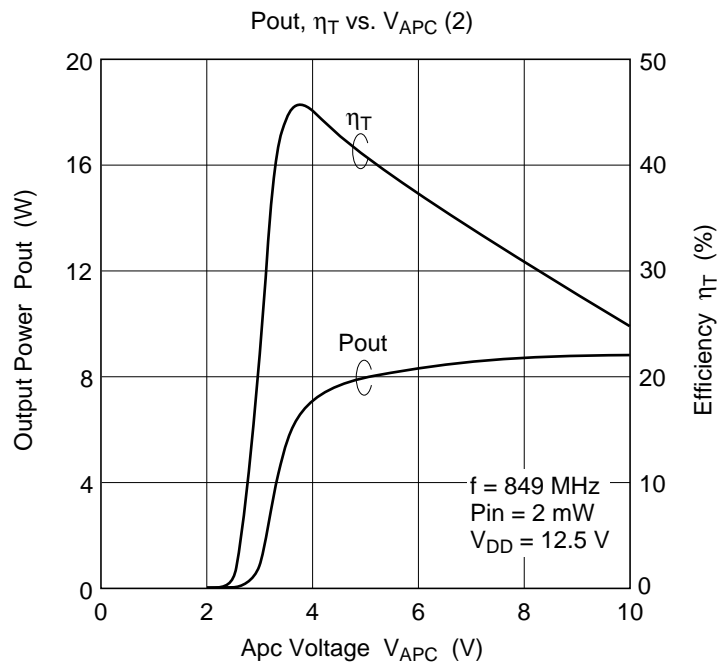
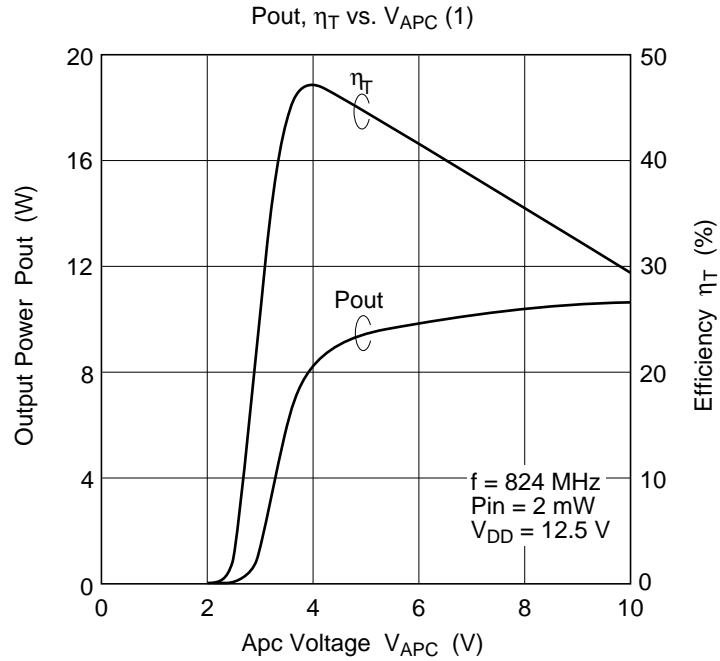

PF0030 Series

PF0030 (cont)

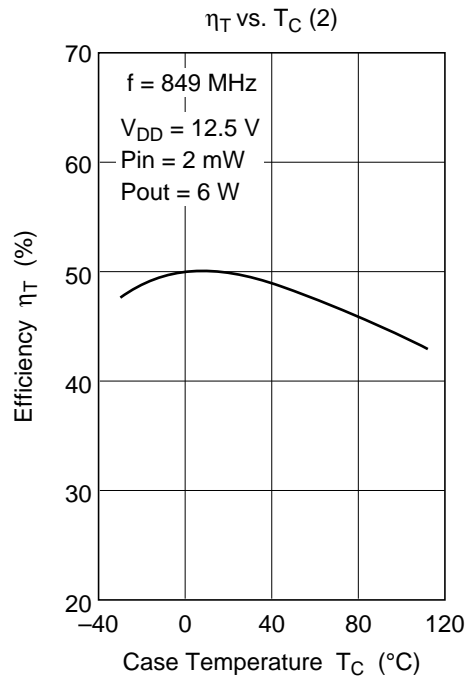
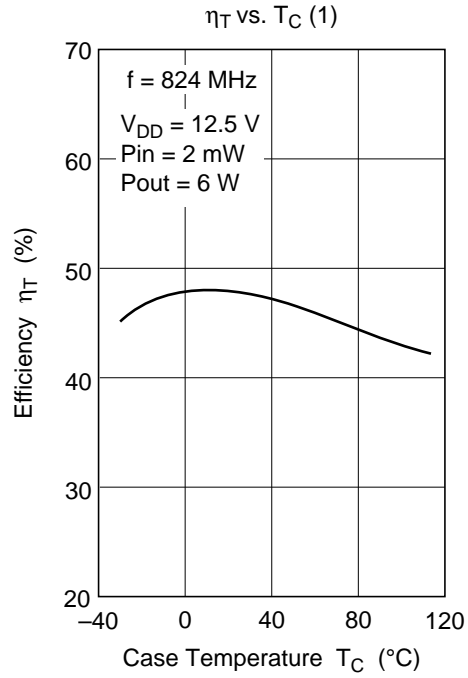

PF0030 (cont)

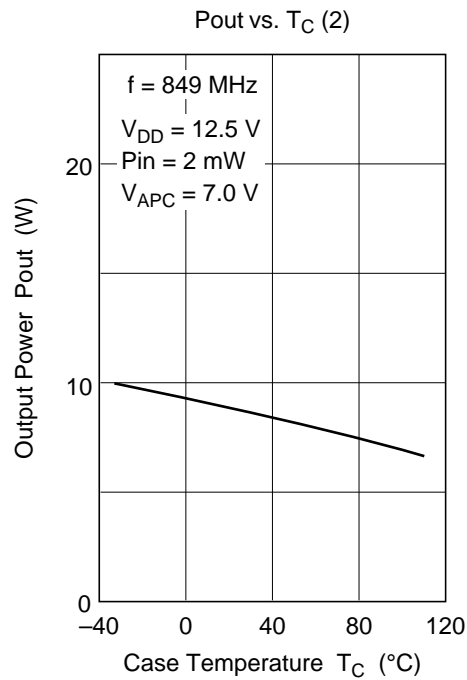
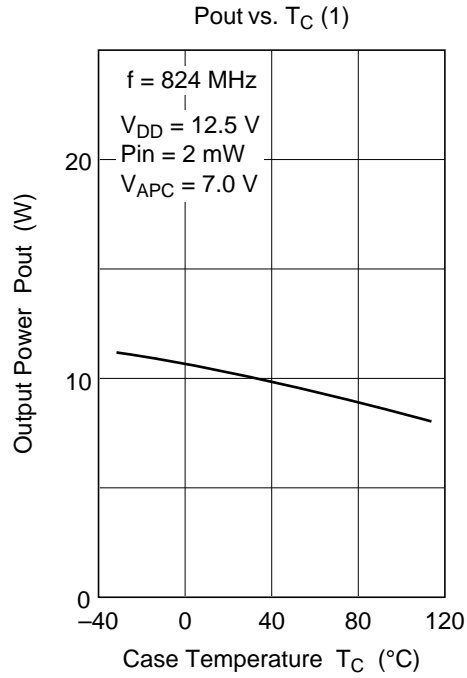

PF0030 Series

PF0032

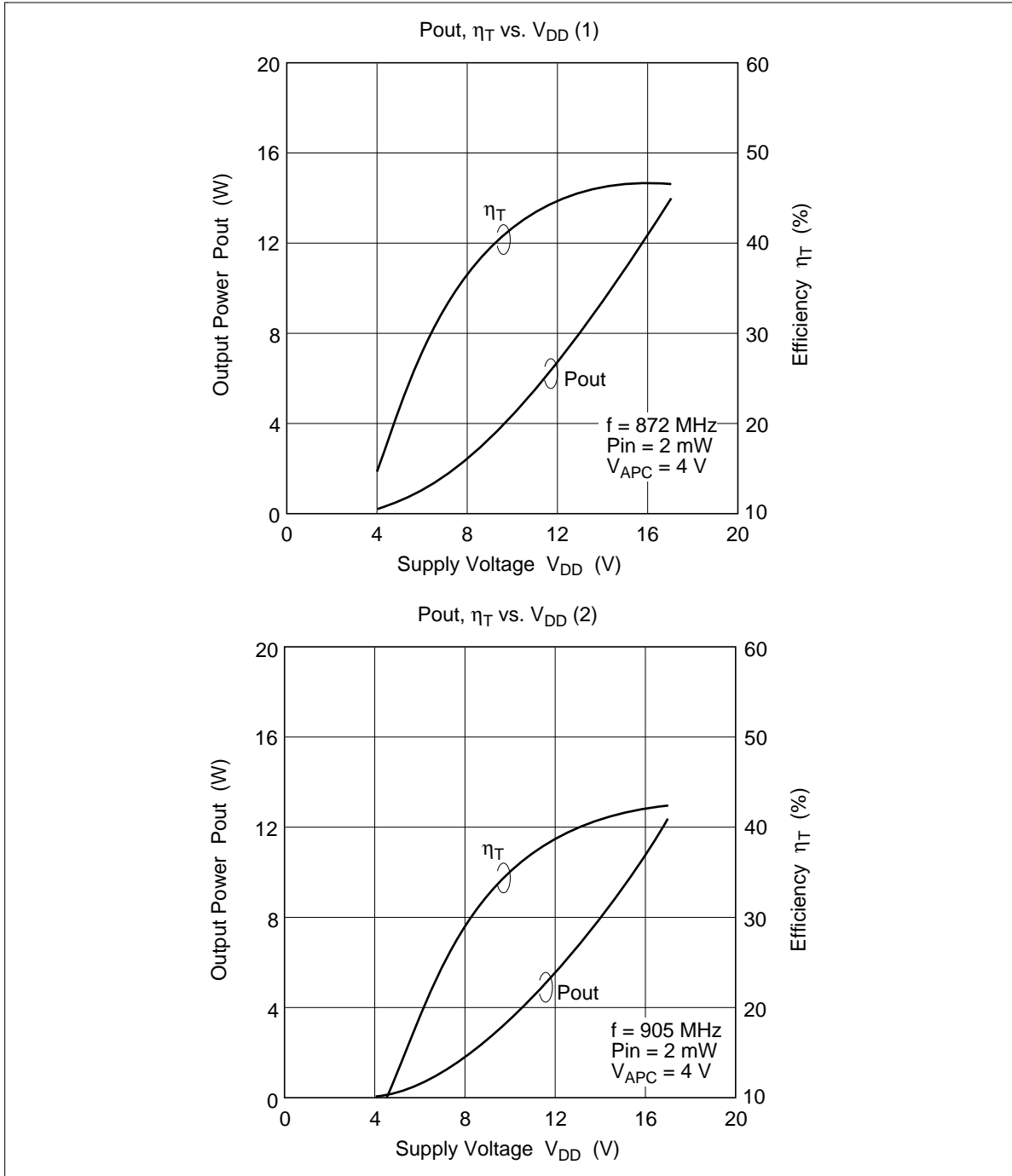

PF0032 (cont)

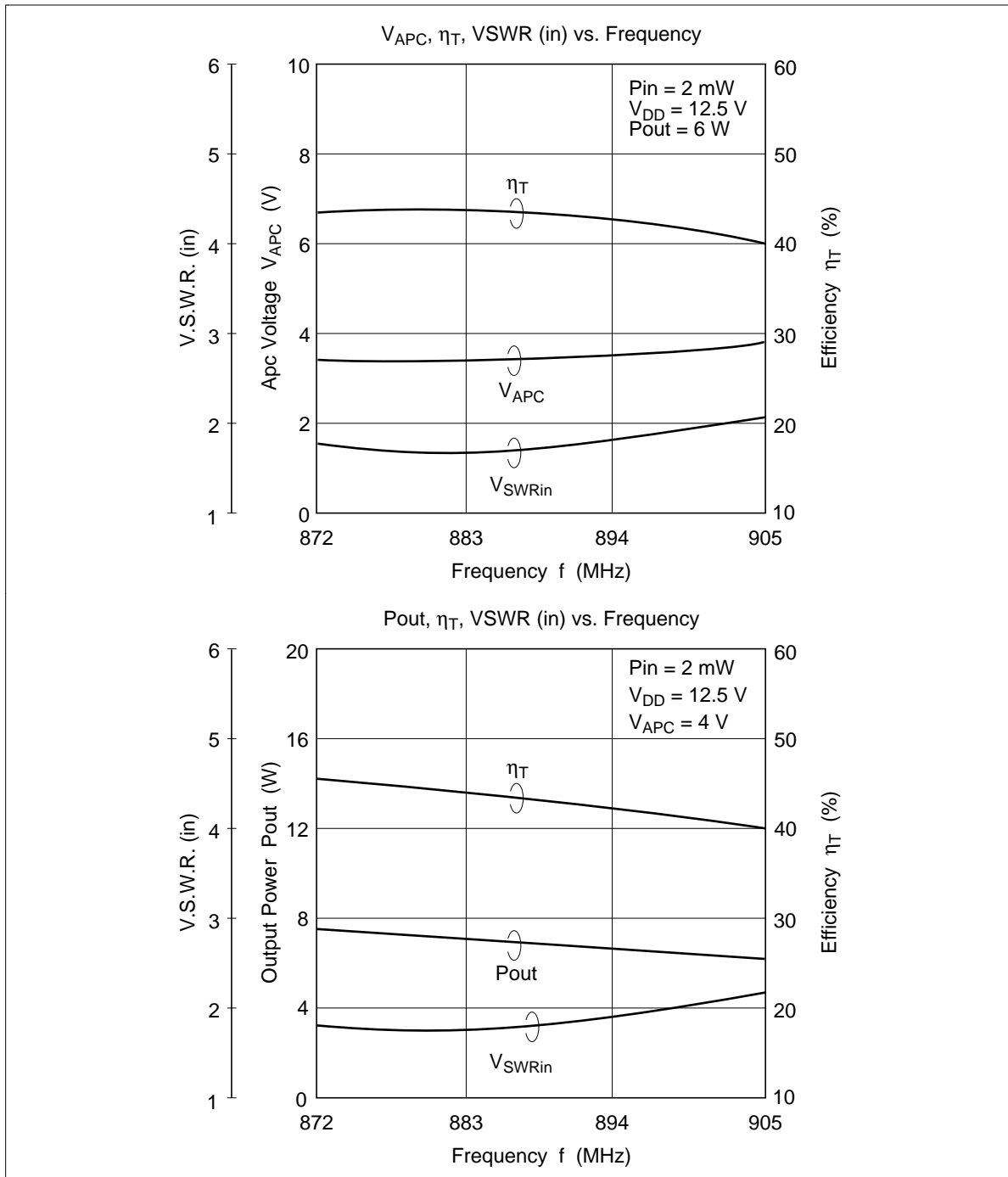

PF0030 Series

PF0032 (cont)

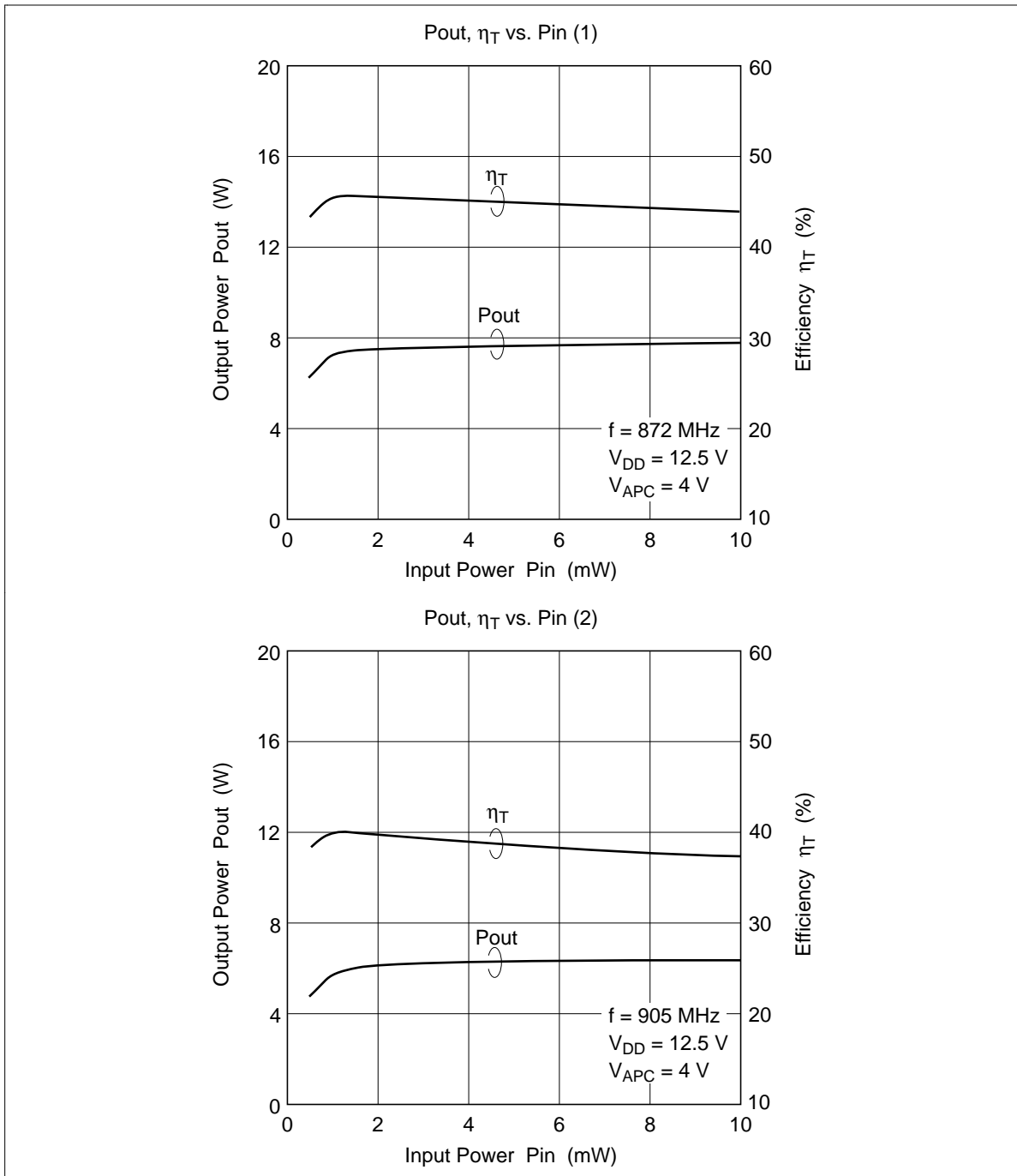

PF0032 (cont)

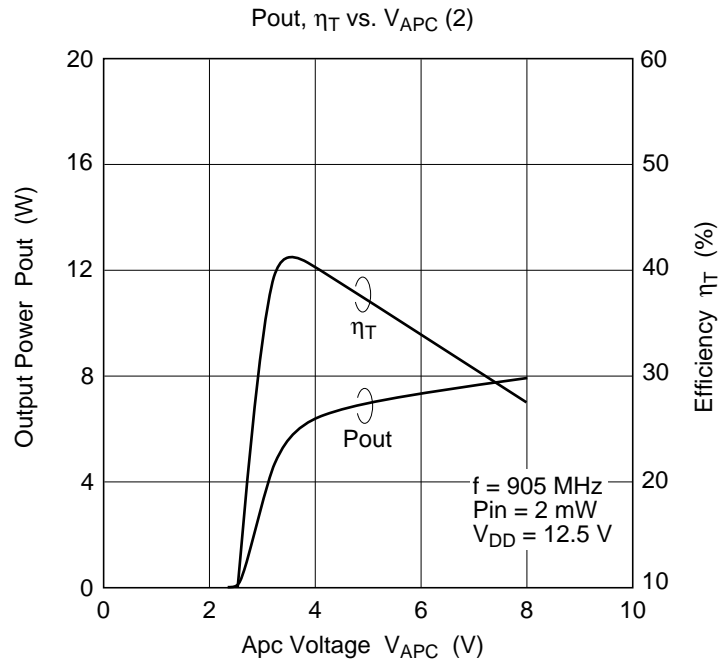
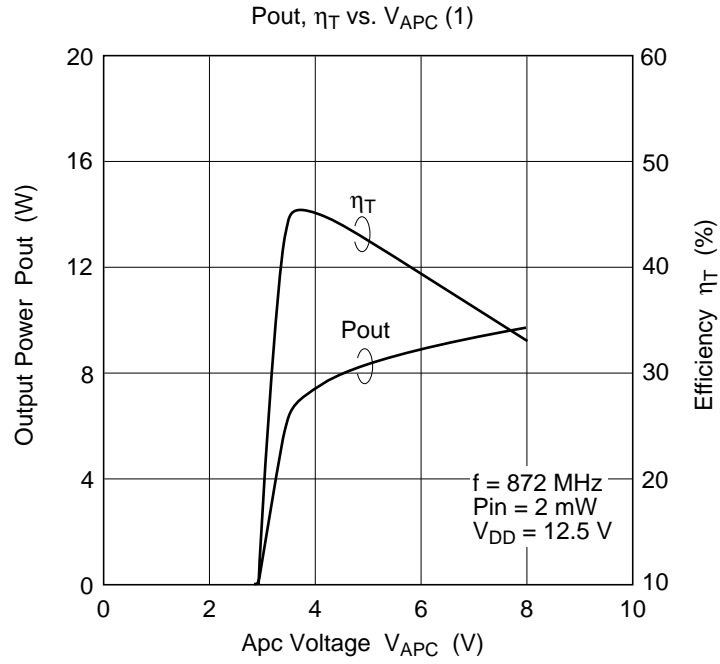

PF0030 Series

PF0032 (cont)

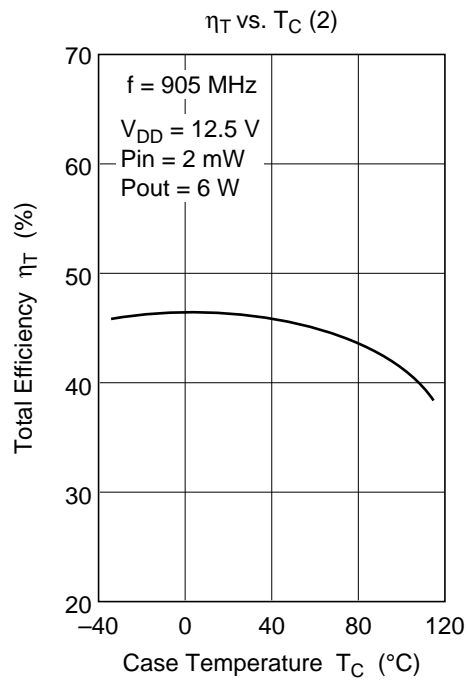
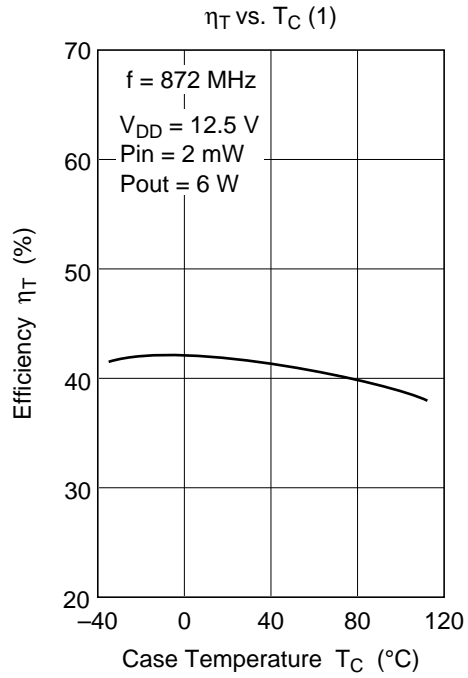

PF0032 (cont)

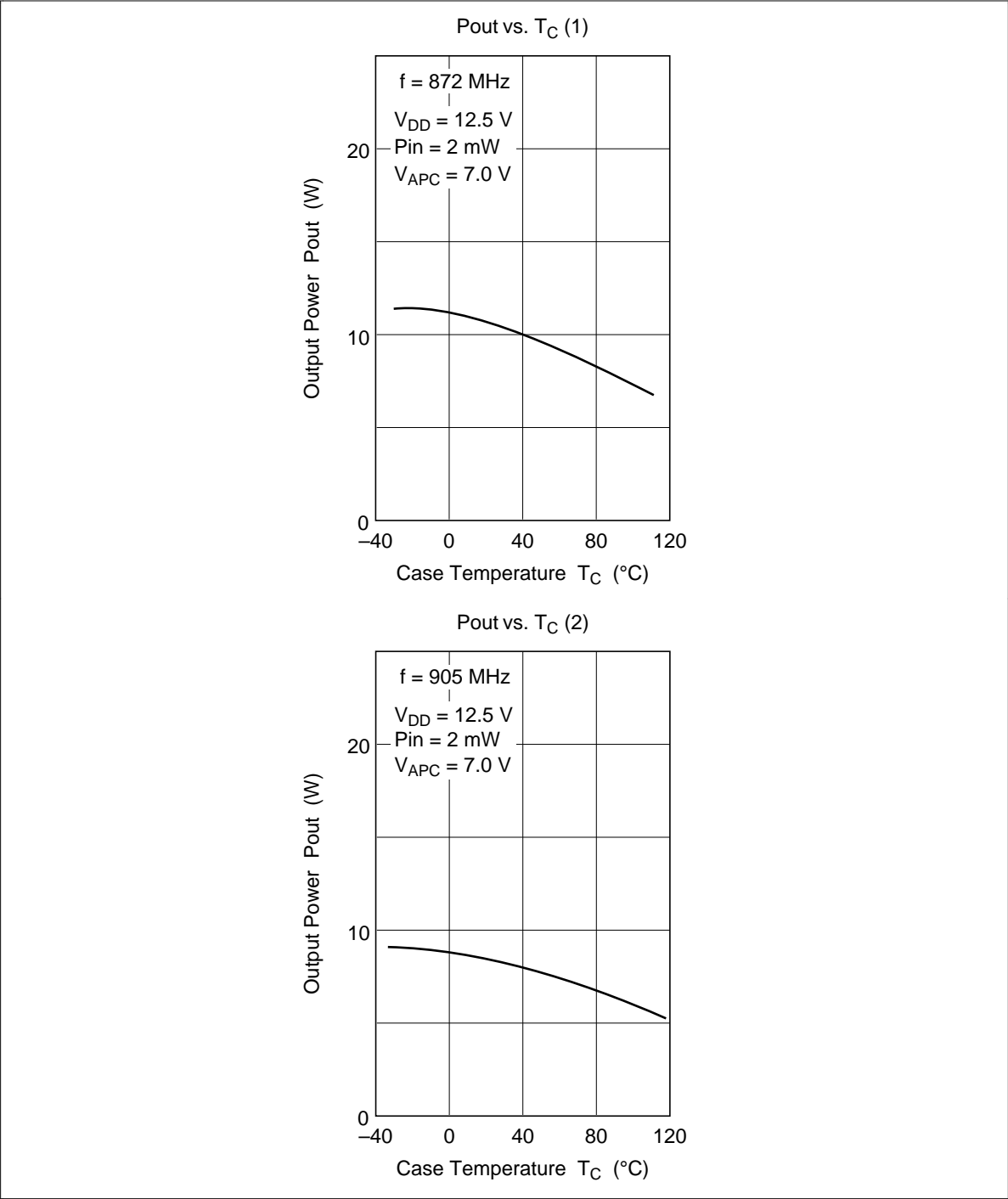

PF0030 Series

Package Dimensions/ Unit: mm

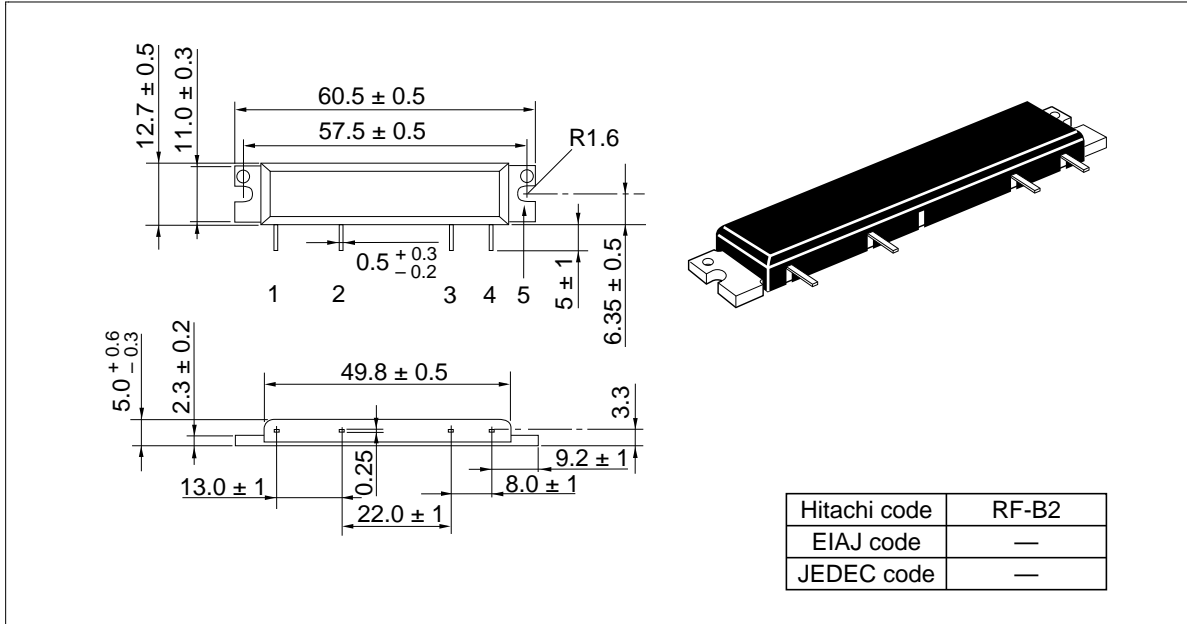

When using this document, keep the following in mind:

1. This document may, wholly or partially, be subject to change without notice.
2. All rights are reserved: No one is permitted to reproduce or duplicate, in any form, the whole or part of this document without Hitachi's permission.
3. Hitachi will not be held responsible for any damage to the user that may result from accidents or any other reasons during operation of the user's unit according to this document.
4. Circuitry and other examples described herein are meant merely to indicate the characteristics and performance of Hitachi's semiconductor products. Hitachi assumes no responsibility for any intellectual property claims or other problems that may result from applications based on the examples described herein.
5. No license is granted by implication or otherwise under any patents or other rights of any third party or Hitachi, Ltd.
6. **MEDICAL APPLICATIONS:** Hitachi's products are not authorized for use in **MEDICAL APPLICATIONS** without the written consent of the appropriate officer of Hitachi's sales company. Such use includes, but is not limited to, use in life support systems. Buyers of Hitachi's products are requested to notify the relevant Hitachi sales offices when planning to use the products in **MEDICAL APPLICATIONS**.

HITACHI

Hitachi, Ltd.

Semiconductor & IC Div.
Nippon Bldg., 2-6-2, Ohte-machi, Chiyoda-ku, Tokyo 100, Japan
Tel: Tokyo (03) 3270-2111
Fax: (03) 3270-5109

For further information write to:

Hitachi America, Ltd.
Semiconductor & IC Div.
2000 Sierra Point Parkway
Brisbane, CA. 94005-1835
U S A
Tel: 415-589-8300
Fax: 415-583-4207

Hitachi Europe GmbH
Electronic Components Group
Continental Europe
Dornacher Straße 3
D-85622 Feldkirchen
München
Tel: 089-9 91 80-0
Fax: 089-9 29 30 00

Hitachi Europe Ltd.
Electronic Components Div.
Northern Europe Headquarters
Whitebrook Park
Lower Cookham Road
Maidenhead
Berkshire SL6 8YA
United Kingdom
Tel: 0628-585000
Fax: 0628-778322

Hitachi Asia Pte. Ltd.
16 Collyer Quay #20-00
Hitachi Tower
Singapore 0104
Tel: 535-2100
Fax: 535-1533

Hitachi Asia (Hong Kong) Ltd.
Unit 706, North Tower,
World Finance Centre,
Harbour City, Canton Road
Tsim Sha Tsui, Kowloon
Hong Kong
Tel: 27359218
Fax: 27306071